

VDO KIENZLE

Montage- und Bedienungsanleitung
Installation and Operating Instructions

VDO
Ocean Line

Sumlog

Contents

Preface	23
Safety Instructions	24
for installation	24
for maintenance	25
The VDO Sumlog	26
System components	27
Accessories	27
Spare parts	27
The functions of the VDO Sumlog	28
Calibration of the VDO Sumlog	28
Troubleshooting	31
Maintenance of the VDO Sumlog	31
Installation of the system	32
Installation of the indicating unit	32
Installation of the sending unit	33
Removal of the sending unit	35
Replacement of the paddle wheel	36
Electrical installation	37
System power supply	37
Connection of a repeater display unit	38
Circuit diagram legend	39
Cable lengths	39
Technical data	39

Manual should always be kept on board!

Preface

With the purchase of an instrument of the VDO marine program you selected a high-quality product, made to the accepted State of the Art. Advanced production methods and the respect of the applicable quality assurance standards guarantee that our products are shipped in excellent condition.

Thank you for your wise decision. We are certain that this system will provide you with valuable assistance and safety at sea.

You should be familiar with all functions of the system to guarantee easy and safe use of your VDO Sumlog.

Please take the time to study this manual completely.

Your VDO Kienzle agent will be pleased to help you, if you have any further questions or problems.

VDO Kienzle Vertrieb und Service GmbH

Safety Instructions

Please respect all instructions in this manual .

All texts marked with this symbol should have your special attention. They are an indication of particular importance regarding the operation of the system and for your safety.



Good seamanship is essential! The use of the sumlog does not relieve you of your responsibility for your ship.

Always use your personal seafaring experience when interpreting the displayed values.

Safety Instructions concerning the installation

The system components should be installed by your shipyard or by a specialist.

Use adequate working clothes if you install the system yourself. Avoid loose clothing that may be caught by moving parts. Use a hair net if you have long hair. Clothing and hair can be caught by moving or rotating parts.

Remove all metallic or electrically conductive jewellery, such as chains, bracelets, rings, etc. when working on the on-board electronics.

Disconnect the minus polarity at the battery before starting work to prevent the risk of short-circuiting. Short-circuiting can cause cable harness fires, battery explosions and damage to other electronic systems. Please note that all volatile electronic memories will lose their contents, and will have to be re-programmed if you disconnect the battery. The VDO instruments are not equipped with volatile memories.

Risk of explosion! Run the engine compartment blower for a certain time before starting work in a gasoline engine compartment.

Check that there is enough space behind the instrument installation opening. Pre-drill the opening and complete the opening with a keyhole saw (respect the safety instructions of the hand tool manufacturer).

When selecting the location for the sending unit check that no stringers will be damaged and similar furniture, floor boards, cables, etc.

Solvent vapours can be produced by the sending unit sealant. Provide sufficient ventilation. Respect the instructions of the sealant manufacturer.

SAFETY

Use insulated tools if you must work without disconnecting the power supply.

The electrical outputs of the Sumlog indicating instrument and the connected cables must be protected against any direct contact or damage.

Capacitors in the unit can retain their charge, even if the unit is separated from its power supply.

The cables must have a sufficient insulation resistance or voltage rating, and touching the contact points should be avoided.

Electrically conductive parts of the connected loads must also be protected against direct contact by adequate measures. The use of non-insulated wires and contacts is strictly forbidden.

Safety Instructions concerning the maintenance

Repairs to the components of the sumlog system may only be made by specialists authorized by VDO Kienzle. The system fulfills the applicable safety regulations.

Capacitors in the unit can retain their charge, even when the unit is separated from its power supply.

The Sumlog sending unit must be cleaned at regular intervals. Dirt prevents or hinders the rotation of the paddle wheel, giving wrong or causing failure of the readings.

For longer periods of inactivity we recommend the removal of the sending unit from its hull sleeve.



Close the hull sleeve with the blind plug when removing the sending unit to guarantee that it remains sealed. The flooding valve integrated in the hull sleeve does not provide permanent protection against the entry of water.

The VDO Sumlog

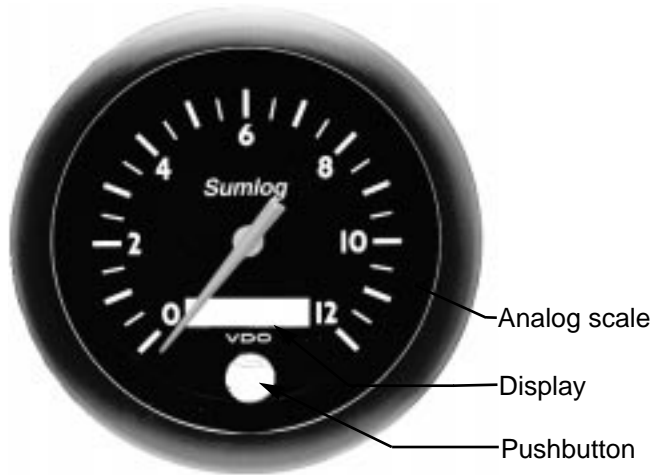

The VDO Sumlog is an advanced speed measuring system, designed for sport navigation.

The pointer displays the speed on an analog scale when the system is active. The total distance or the trip distance travelled is shown by the display in the lower dial section.

The indicating unit has a front pushbutton for the necessary basic settings and for the selection of the displayed value. Using the instrument is simple.

Up to two repeaters can be connected to the main instrument.

VDO SUMLOG

System components

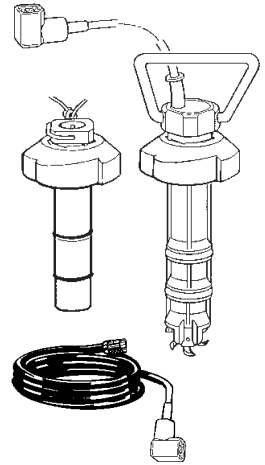
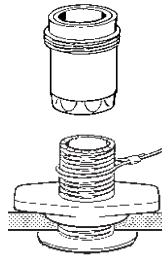
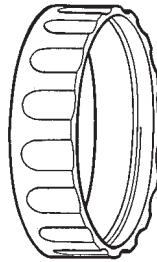

The system, as supplied, consists of:

- Indicating instrument
- Union nut for indicating instrument fixation
- Sumlog sending unit with paddle wheel and cable, length 1 m
- Connecting cable between sending unit and indicating unit, length 10 m
- Hull sleeve for Sumlog sending unit, with sealing washers and fixation nut
- Flooding valve for Sumlog sending unit
- Blind plug for Sumlog sending unit with control rope
- Installation and operating instructions

Accessories (not supplied with the system):

- | | |
|---|-------------|
| - Fixation parts kit (studs and bracket) | N05 800 792 |
| - Lighting parts kit (24V / 1.2W) | N05 800 550 |
| - Second indicating instrument VDO Sumlog 0 - 12 | N01 110 902 |
| - Second indicating instrument VDO Sumlog 0 - 30 | N01 110 908 |
| - Second indicating instrument VDO Sumlog 0 - 50 | N01 110 920 |
| - Second indicating instrument VDO Sumlog 0 - 50 (kn/mph) | N01 110 914 |

Spare parts

- | | |
|---|-----------------|
| - Paddle wheel with shaft (12 kn, km/h, mph) | 270.023/005/003 |
| - Paddle wheel with shaft (30 and 50 kn, km/h, mph) | 270.023/005/005 |
| - O-ring for sending unit / blind plug (1x) | N05 800 374 |
| - Illumination parts kit (12V / 1.2W) | N05 800 552 |

Other spare parts are available on request.

The functions of the VDO Sumlog

The analog indication shows the boat speed, while the display shows either the total distance or the trip distance travelled, depending on the selection, when the power is switched on.

The distance is selected by short activation of the pushbutton.

Example:

Indication of the total distance (2312.3 in this example)

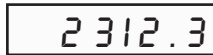
A rectangular digital display showing the number 2312.3.

or of the trip distance (12.96 in the example)

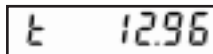
A rectangular digital display showing the number 12.96.

The units of the indicated speed and distance depend on the selected calibration factor (see page 29).

The total distance is displayed from 0.0 to 99999.9 and the trip distance from 0.0 to 999.99, thereafter the counter rolls over to zero again.

The trip distance is reset to zero by keeping the pushbutton pressed for about 5 seconds when the trip distance is displayed.

Calibration of the VDO Sumlog

After installation of the system your VDO Sumlog must be calibrated to obtain speed and distance measurements with the maximum accuracy. Mark two distinct points on the map. The distance between these two points defines the measuring length (see page 29). During the trip from one point to the other, the VDO Sumlog measures the covered distance. In flowing waters it is necessary to make the measuring run in both directions to compensate for the influence of the current.

For indicating units with a simple graduation (12, 30 or 50 without unit indication): Select the desired display unit (knots, mph or km/h) for your operation prior to the measuring run.

Please note that it is not possible to switch to a different indicating unit after calibration; this requires a new calibration.

For the indicating unit with twin graduations (50 kn/mph): Select nautical miles as the unit for the measuring length.

CALIBRATION

Measuring length:

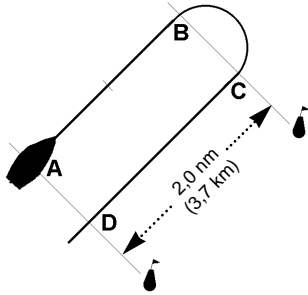

Make a measuring run at a cruising speed, which remains as constant as possible.

Check that the calibration factor is $C=1.00$ (as supplied) at the beginning of the measuring run, and that the trip distance counter is set to zero.

The following example refers to a measuring run in water without a current with a measuring length of 2 nautical miles (nm).

Approach starting point A of the measuring length.

Set the trip distance counter to zero (see page 28) when passing starting point A.



Follow the measuring length on a straight line and note the indicated value (1.74 nm in this example) when passing end point B.



Calculate the calibration factor C with the following formula:

$$C = \frac{\text{Effectively covered distance (A-B)} \quad 2.00 \text{ nm}}{\text{Indication of the display (A-B)} \quad 1.74 \text{ nm}} = \frac{\text{-----}}{\text{-----}} = 1.15$$

Enter the calculated calibration factor C (1.15 in the example) as follows: Keep pushbutton pressed and switch the indicating unit power supply on. The display shows „CAL“.

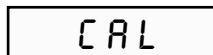

Release the pushbutton. The current calibration factor is displayed (as supplied: 1.00):

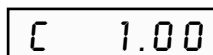

CALIBRATION

Press the pushbutton to increment up to the calculated calibration value. Each press increments the value by 0.01. Incrementing is automatic if you keep the pushbutton pressed.

C 1.15

The calibration factor setting range is from 0.50 to 2.50. On reaching 2.50 the counter rolls over to the calibration factor 0.50 again.

The set calibration factor is stored if the pushbutton is not activated for a further 5 seconds. The display then automatically changes to display the total distance.

The calibration factor also applies to the speed indication.

In the case of a measuring run in flowing water repeat the same distance measuring steps in the opposite direction (measuring length C-D).

The calibration factor is calculated with the following formula:

$$C = \frac{\text{Effectively covered distance (A-B) + (C-D)}}{\text{Indication of the display (A-B) + (C-D)}}$$



Do not use the GPS navigator as a reference for VDO Sumlog calibration. The GPS Navigator indicates speed over ground (SOG), but the VDO Sumlog measures speed through water.

Troubleshooting

Fault:

Cause and correction:

- | | |
|--|---|
| <ul style="list-style-type: none"> - No Sumlog function
 - No Sumlog function - Pointer stays at zero at speed
 - Wrong indication | <ul style="list-style-type: none"> - Check electrical connections per wiring diagram. - Check supply voltage, Supply voltage 10.8...32 VDC, - Check fuses in fuse box.
 - Check free movement of paddle wheel,remove dirt deposits, replace paddle wheel if necessary.
 - Check paddle wheel shaft for wear, replace paddle wheel if necessary. - Paddle wheel direction not optimised,check installation. - Recalibrate unit. |
|--|---|

Maintenance of the VDO Sumlog

The indicating unit is maintenance-free. Use a humid, lint-free or antistatic cloth for cleaning. Do not use cleaning detergents.

On the sending unit, check the paddle wheel and the paddle wheel shaft for wear once per season. Both paddle wheel and paddle wheel shaft must be replaced together if the clearance is excessive (see page 36). Check the two O-rings on the sending unit and the two O-rings of the blind plug for wear, brittleness or damage at regular intervals (twice per season). Even the slightest wear requires O-ring replacement.

Order numbers:

Paddle wheel with shaft (12 kn, km/h, mph)	270.023/005/003
Paddle wheel with shaft (30 and 50 kn, km/h, mph)	270.023/005/005
O-ring for log sending unit / blind plug (1x)	N05 800 374

INSTALLATION

Installation of the VDO Sumlog system



Please read the safety instructions on pages 24 and 25 prior to the installation.

Installation of the indicating unit

- Drill a hole, 86 mm dia., at an suitable location.
- Clean the material and remove any chips before inserting the indicating instrument.

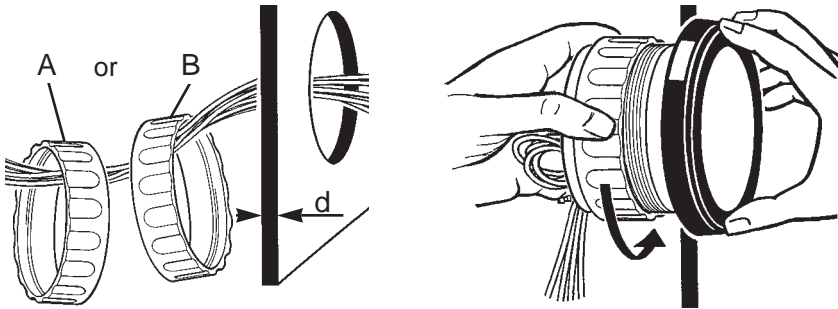

- Thread the indicating instrument cables from behind the mounting hole through the housing mounting nut.
- Place the supplied black rubber ring on the instrument back.
- Make the electrical connections of the indicating unit per circuit schematically (see „Electrical Installation“) and insert the instrument into the installation hole.
- Secure the instrument by tightening the housing nut.
At $d = 0.5$ to 6.5 mm, installation A.
At $d = 6.5$ to 16.5 mm, installation B.
- The housing nut should only be tightened by hand.

Install the indicating instrument with studs and bracket (see page 33) if you expect strong vibrations at the location where the instrument is to be installed (e.g. high-speed boats).



INSTALLATION

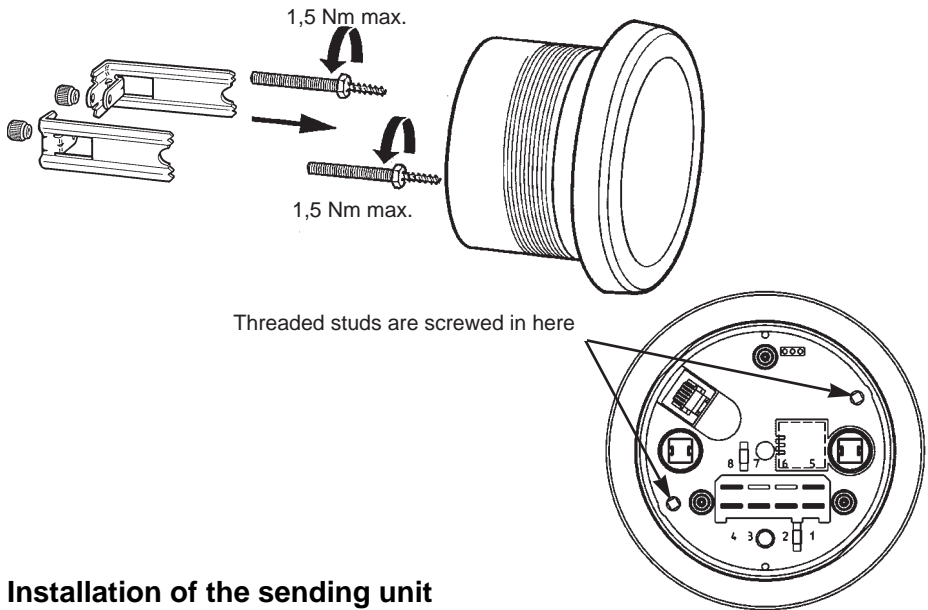

Installation of the sending unit

The sending unit must be installed in a turbulence-free zone in the hull. If an echo sounder is installed, the Sumlog sending unit should be installed at the same height and to the side of, or laterally offset to the echo-sounder. Check for sufficient distance to stanchions, stringers, bulkheads, etc. when drilling the hull.



Do not install the sending unit close to external valves, anodes, etc. to avoid influences by turbulence.

Installation on sailing boats:

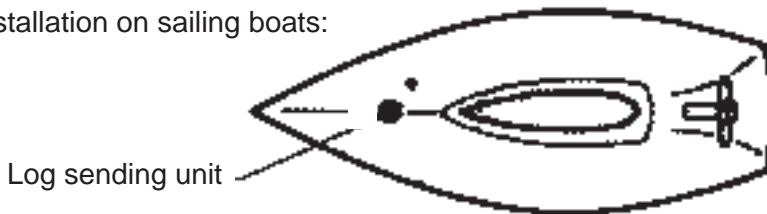

On sailing boats the sending unit should always be installed in front of the keel, as close to the longitudinal ship axis as possible. On boats with a long keel the installation should be at the end of the first third of the hull, but not at the widest location of the hull.

On powerboats the sending unit should be installed at about the first third of the hull and never towards the stern in a zone of strong turbulence or up front, where strong disturbances by air induction must be

INSTALLATION

expected.

An ideal installation is near the longitudinal axis of the ship and in the zone of the first stringer, directly in front of the engine compartment if possible. At higher speeds this is the only location where a disturbance-free operation can be expected.

Installation on powerboats:

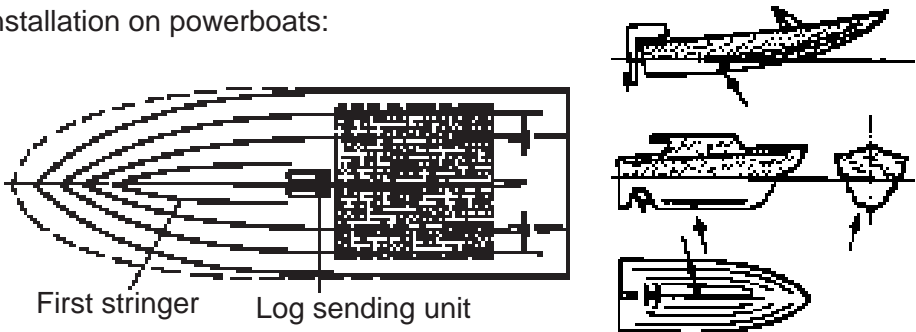

Make a hole 39 mm dia., at a suitable location. The wall thickness can be up to 30 mm. Camber the hole out at 45 degrees for good sealant distribution during the assembly. To install the hull sleeve and the sending unit proceed as follows:

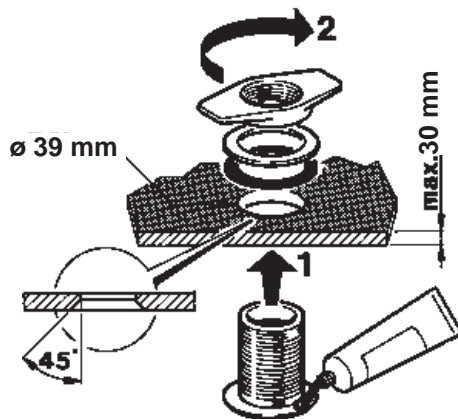

1. Put salt-water resistant sealant on the hull sleeve flange and introduce the sleeve from the outside into the hole.
2. From the inside, install the black sealing ring on the hull sleeve, then the white one, and screw the fixation nut down. Lightly hand-tighten the fixation nut at first. After letting the sealant harden, tighten the nut another $\frac{1}{4}$ turn by hand and check the hull feedthrough for leaks.

INSTALLATION

Install flooding valve and sending unit:

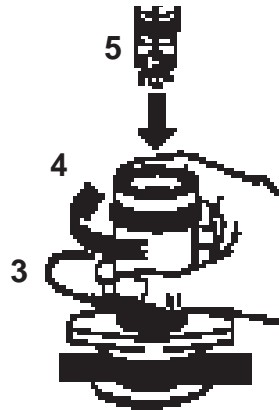

3. Put the loop of the control rope around the hull sleeve and knot the loose end of the rope to the blind plug.
4. Screw the flood valve to the hull sleeve until an audible click indicates secure seating, is heard.
5. Insert the sending unit from the top and secure it with the nut.

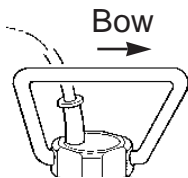

Note the correct direction when inserting the sending unit. The pointed side of the sending unit loop must be directed towards the bow as soon as the sending unit has been inserted.

Removal of the sending unit

Loosen the union nut and pull the sending unit from the sleeve by rotating it slightly. Immediately insert the blind plug.



Never pull on the cable to remove the sending unit. Always use the loop. Always insert the blind plug when the sending unit has been removed.

INSTALLATION

Replacement of the paddle wheel

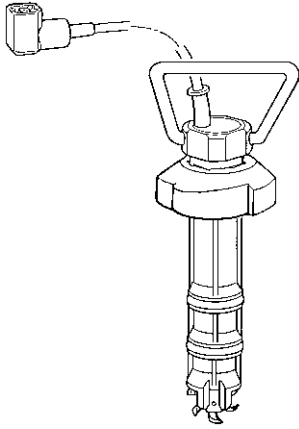

The paddle wheel of the sending unit is rotated by the flow of water. The rotational speed of the paddle wheel is measured without contacts, and transmitted to the indicating instrument.

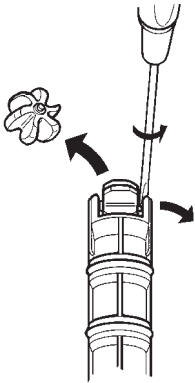

Use a screwdriver to replace the paddle wheel and its shaft.

Carefully lift the paddle wheel shaft upwards to remove it from the sending unit.

Insert the new shaft into the new paddle wheel and install shaft and wheel, again using the screwdriver.

Check the correct installation direction when replacing the paddle wheel. The spoon-shaped leading surface of the wheel (A) must be directed towards the pointed side of the loop (S).

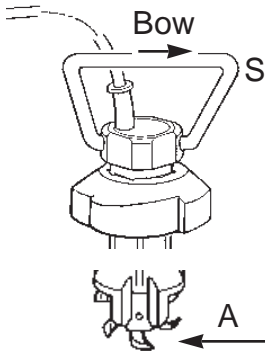

The pointed side of the loop must be directed to the bow when the sending unit is inserted in the hull sleeve.



Paddle wheel for indicating range 12 (kn, km/h, mph)



Paddle wheel for indicating range 30 and 50 (kn, km/h, mph)

INSTALLATION

Electrical installation

System power supply

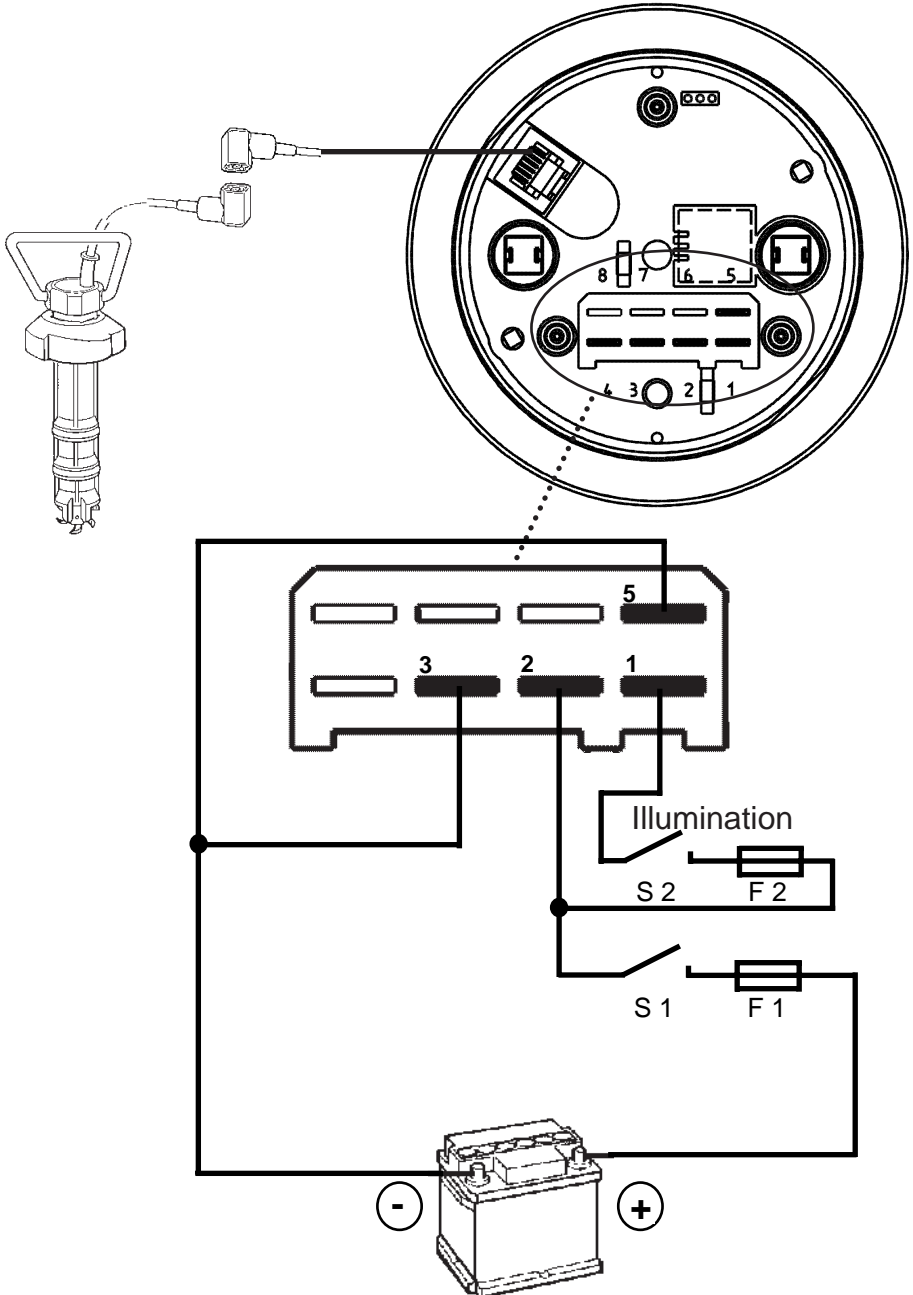

INSTALLATION

Connection of a repeater display unit

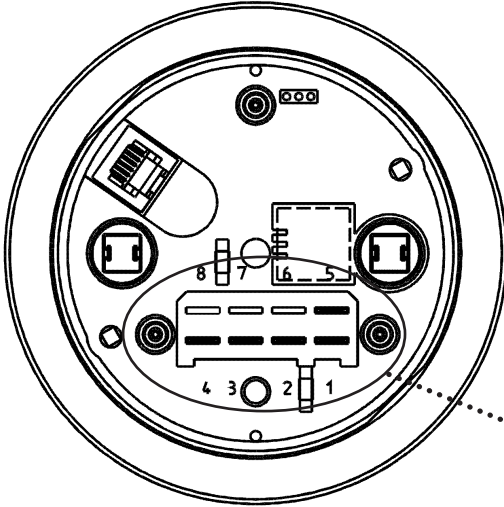

Main unit

Make the power supply connection for the repeater the same as the main unit (s.p. 37). The connection between the main unit and the repeater is shown in the diagram below.

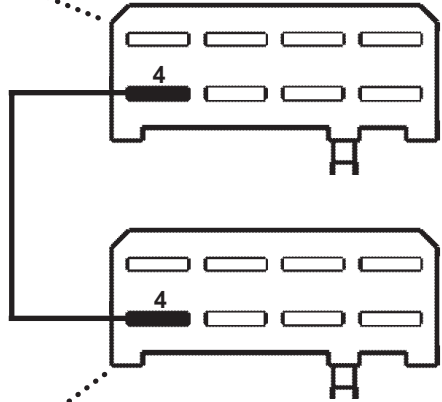

Repeater

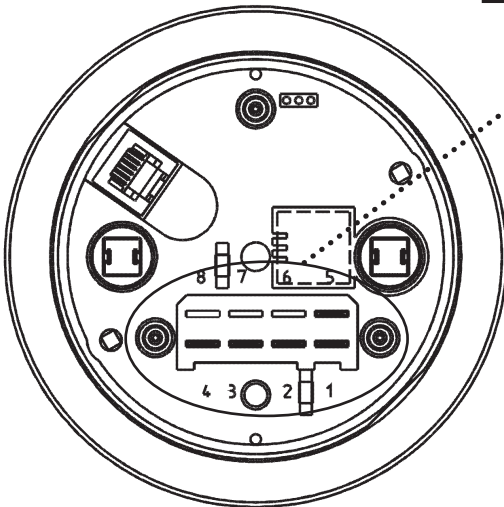

Note that the calibration factor C must also be set (see page 28) on the slave instrument if such an instrument is connected.

Circuit diagram legend:

- S1 On/Off switch for navigation instruments
- S2 On/Off switch for instrument lighting
- F1 Fuse for navigation instruments (5 A)
- F2 Fuse for instrument lighting (5 A)

Recommended cable section: 1.5 mm²

Cable lengths:

Log sending unit - Indicating instrument	20 m max.
Indicating instrument - Repeater	10 m max.
Repeater 1 - Repeater 2	10 m max.

Technical data:

Measuring principle:	Pulse count by Hall sensor
Supply voltage:	10.8 V to 32 V DC
Current consumption:	about 100 mA at 12 V DC (without illumination), about 260 mA with illumination
Operating temperature:	-10 °C to +60 °C
Type of protection:	DIN 40050 - IP 65 at front
EMC protection:	CE: EN 50081-1, EN 50082-1
Dimensions:	Indicating instrument:
	Front ring diameter 105 mm
	Installation diameter 86 mm
	Installation depth 56 mm (union nut)
	Installation depth 90 mm (bracket)
	Hull sleeve:
	Installation diameter: 39 mm
	Maximum hull thickness: 30 mm

VDO
Ocean Line

Sumlog

05-97 -

08 601 102

VDO Kienzle Vertrieb und Service GmbH
Kruppstrasse 105
D-60388 Frankfurt am Main

Tel.: +49 (0)69 40805-0
Fax: +49 (0)69 40805-177
e-mail: vdmarine@vdokienzle.com
Internet: www.vdokienzle.com/marine